



General Information



Scope of Supply



General Technical
Characteristics



Connection with PC



General Installation
Overview



Certifications and
Standards



EFI-X BPU™ v1.x USB

Product Introduction



Copyright © 2010 by ASEM Co., Ltd. All rights reserved.
All other trademarks, tradenames, company names and service
marks are the respective properties of their holders.

ASEM

Art Studios Entertainment Media Co., Ltd





Preface

 This Product Introduction provides general system data and information about the EFi-X BPU™ device. Furthermore, our project and sales departments are available to advise you on more specific questions concerning our products and regarding the installation and usage of the EFi-X™ devices.

 Our product is constantly reviewed and redesigned according to the technology development and needs of our customers. Therefore, we reserve the right to make changes to any data and information herein without notice.

 All information provided by this publication is meant to be informative only. All project specific issues shall be agreed separately and therefore any information given in this publication shall not be used as part of agreement or contract.

Art Studios Entertainment Media (ASEM) Co., Ltd
6F.,No. 1-1, Nanjing W.Rd
Zhongshan District, Taipei City 104,
Taiwan (R.O.C.)

Tel: +886 (0) 2-8512-4946

Fax: +886 (0) 2-8512-1790

www.art-studios.net

EFiX, EFi-X, BPU are registered trademarks of
Art Studios Entertainment Media Co.,Ltd.

© 1998 - 2010 Art Studios Entertainment Media. All rights reserved

Doc. no. EFEC01E rev. B / 01th February 2010, Germany



Index of items

Preface.....	3
Index of Items.....	4
1. General Information.....	5
What is EFI-X™?.....	5
General Efi-X™ Features and Functionality.....	6
The EFI-X™ Key Benefits.....	8
EFI-X™ Firmware Update.....	9
2. Scope of Supply.....	13
EFI-X BPU™ Module.....	13
General Information.....	14
EFI-X™ Specific Basic Items for Delivery.....	15
EFI-X™ Specific or Contract Specific Optional items.....	16
Package.....	17
Retail Box.....	18
3. General Technical Characteristics.....	19
3.1. Main Dimensions and Weights.....	19
3.2. Technical Characteristics.....	20
3.3. Ambient Reference Conditions.....	22
4. Connection with PC – Block Diagram.....	23
5. General Installation Overview.....	24
6. Certifications and Standards.....	27



1.1. What is EFI-X™?

***Plug a small device into your PC-Motherboard
and open a new world for yourself, a world
where Windows, Mac OS and Linux are
finally united and work for you!***

 The ongoing and future trend in the modern world of computer technologies is use of different and multiple operating systems. To date, if you would like to install more than one operating system on your personal computer, a so called "boot manager" is absolutely necessary.

 The EFi-X is the first in the world to bring you a patented hardware boot manager. It includes a highly accurate automatic detection system using algorithms to scan any form of media to determine the partition type, OS type, OS version, OS bitrates and much more.

 It is designed to help any user easily install, configure, and use any operating system you choose and also to guarantee complete and correct interaction between them. With the EFi-X users no longer need to feel intimidated or afraid to install one or multiple operating systems because we have made the process fully automated and understandable for anybody with only basic computer knowledge.

Combining the two words "EFi" and "FiX" we aim to replace the BIOS or EFi and make the process friendly to all users.





1.2. General EFi-X Features and Functionality

BIOS / EFi Error Detection and Correction

 The EFi-X detects errors in a computers BIOS, EFi, and in SPI Flash on Random Access Memory (RAM) and corrects them in real time.

Boot-manager

 The EFi-X is a product with many unique features and replaces any known boot managers on the market today. Because the EFi-X is a hardware boot manager, it is not affected or vulnerable to viruses, malicious programs, or attacks by hackers. This feature is patented and can only be offered by EFi-X. Our product offers such abilities like automatic detection of Disk type, Partition type, Media type, OS type, OS bitrates, and much more.

 It also does not mark or set any flags in any way on your bootable media such as a Hard Disk Drive (HDD) or any other media, which is another unique and patented feature. The EFi-X also differs from other boot managers by remembering the last media you used previously and automatically boots from this device. You have the option to modify your choice on the boot screen, but if you don't, it will simply boot your last drive and OS.



General EFi-X Features and Functionality

Support of Non-Standard Operating Systems on a PC



A very magnificent additional feature the EFi-X™ offers is the installation and booting of Operation Systems which were designed for other platforms or in other words – The EFi-X™ offers support of PC incompatible Operation Systems.



Mac OS – The EFi-X™ allows the installation of a licensed Retail version of Apple's Mac OS X© version 10.5 or 10.6 on any Personal Computer.

Our frequently updated Mac OS X Hardware Compatibility List (HCL) can provide you with more specific information regarding currently supported hardware in case you choose to take advantage of using this beautiful OS on your personal computer

www.art-studios.net/macoshcl



1.3. EFI-X™ Firmware Update

 So herewith we do present to you the EFI-X™ Control Center - The ultimate update and control system for your EFI-X™ device which allows you to update the Firmware via simple mouse clicks. You can download EFI-X™ Control Center at any time point for free from our official website:

www.art-studios.net/support/download



1.4 The EFI-X™ key benefits

Hardware Boot Manager

- A fully automated system and media detector
- Doesn't require any settings made by user
- Protected against Virus and another malicious programs
- Support of Non-Standard Operating Systems on a PC
- Fully automated OS detector
- Fully automated Media detector
- BIOS / EFi / RAM SPI error correction

Continuous developments of new and exiting Features

Rock Solid design

Grade A built:

EFiX is built with materials of the highest possible grade, Grade A. Better materials ensure a stable, durable and safe operation.

Fast CPU:



At the core of V1.1 there is a new and more energy efficient hardware CPU that processes internal data in a blazing fast way, and an eye of regard towards energy consumption.

Internal USB header connection:



Keep your EFI-X safe by connecting it internally through the internal USB header, specially crafted in order to be easily attached on any motherboard, minimizing interferences and hiding it from unwanted eyes in a working environment. Keep all your external USB ports free to connect you with the world and let EFI-X work its magic from within.



The EFI-X™ key benefits



Compact and sleek design:

EFI-X is not only powerful. It is also sleek, beautiful, and very flat. It can be placed conveniently even in the most space-conscious multimedia case.



Tantalum or Niobium Capacitors:

With its cutting edge military grade Tantalum or Niobium Capacitors, EFI-X now affirms itself as one of the best built devices in the market. Such capacitors enable maximum energy efficiency and the lowest dispersion available. This type of capacitors will never dry out or leak the electrolyte like any common types of electrolyte capacitors.



Voltage Regulators:

Power is nothing without control. And by controlling the output with the new voltage regulation subsystem, EFI-X V1.1 can continue normally operate even by overvoltage of USB Power (USB+ and USB-) till approx. 25Volt, allowing a far greater margin of tolerance in extreme situations.



New high quality Quartz Resonators:

Fine tuned to the most impossible and crazy speeds, the new resonators ensure the correct speed, energy consumption and temperature of V1.1. "Bring it on!" is what V1.1 screams when plugged into any extreme environment.



The EFI-X™ key benefits



New Data Line Filters:

Electrical noise is now beaten. Introducing our new Data Line Filters, our new EFI-X features a, faster and more energy savvy throughput, and overall better, cleaner performances.



Extra memory onboard:

To ensure a better and safer operation, we have added extra and faster memory on V1.1, so that each firmware upgrade is loaded in a "cache zone" before being loaded into the core. This greatly improves the reliability of the device.



Gold Plated Multilayer PCB:

EFI-X is precious and valuable, literally. Its motherboard is coated in gold, to ensure clean, instant communications among the components with almost null energy dispersion. EFI-X is the best jewel you can give to your PC!



EFI-X™ Firmware Updates:

Your EFI-x is always up to date with our Control Centre applications, Updating the firmware has never been easier. One click, and you are in a new world!

A simple Graphical User Interface (GUI)



Supported OS

Supported OS:

- Windows Vista 32/64 Bit
- Windows 7 32/64 Bit
- Mac OS X 10.5
- Mac OS X 10.6
- Linux

Upgradable Hardware:

 Hardware Upgrade Program: Worried about purchasing a device in a world of computers that is always changing and upgrading? Don't want to purchase because you are afraid that your device will be outdated 6 months after you purchase it? Well now you can have the peace of mind of knowing that your EFI-X is upgradable through ASEM's EFI-X Hardware Upgrade Program. This special program guarantees special "upgrade" prices along with the trade-in of your old device to make sure you are always on the most recent hardware version. This program is available exclusively for ASEM Premium Support Members. Not a member yet? Join here at

www.art-studios.net/support/registration

2.1 EFi-X BPU™ Module





1. EFi-X™ Body
2. Manufacturing country
3. Serial Number
4. USB Connector
5. EFi-X™ Logo with Product Version number etched by laser



2.2 General Information

 The EFi-X™ has been very carefully thought out and designed. Every part of it has been developed with German love and care with accuracy and an extreme attention to details. It has been assembled with the help of many advanced technologies to bring you the highest quality product possible. The Package of EFi-X™ – it is a masterpiece of the creative inspiration by the best designers, is very convenient and compact, with the highest quality, well manufactured in an ultra modern style. It will not take much space and will for sure make your eyes happy for a long time.

 EFi-X™ Body represents a high-tech produced plastic mold, like jewelry reworked (processed), on which is etched by laser gravure, made by one of most thin and modern lasers. Entire manufacturing technology is considered worldwide to be most advanced and does not have analogues in the world yet.

 Internal 10-1 USB connector uses the USB standard 2.0 and does contain so called "key"-pin, which was designed for protection of EFi-X™ device against incorrect connection in to on-board USB plug on your motherboard. For your convenience a standard Retail Boxed version of EFi-X™ contain additional 10 cm USB cable extender. The cable does have protection "key"-pin and EFi-X™ official logo too.

 Please pay attention that some of manufacturers do use on the motherboard exact same type of 10-1 connectors for USB and Firewire, Be extreme cautious and before you would like to connect your EFiX device make sure that you choice correct plug, USB, for connection. If you are not certain about the correctness of your choice, so you would need to confirm it with the user manual supplied by the manufacturer of your motherboard.

2.3 EFI-X™ Specific Basic Items for Delivery

There are two kinds of standard bundles:

- Retail Boxed (for additional information see page 18)
- OEM (for additional information see page 20)

Standard Retail Boxed version contain following items:

1. Package with magnet opening system (1 pics)
2. EFI-X™ Sticker (1 pics)
3. 10 cm Extension Cable (1 pics)
4. EFI-X BPU™ device (main body, 1 pics)



2.4 Efi-X™ Contract Specific Optional items



For EFi-X™ does exist following accessories:

1. USB 10-1 Extension Cable 20 cm



2. USB 10-1 Extension Cable 25 cm



2.5 Package



EFi-X™ package represents unique designer solution, convenient and well designed box for secured storage and transportation of EFi-X™ devices.

2.6 Retail Box

Retail Box.

Made by following several elements (parts):

1. Base Box with magnet opening system
2. Black inside holder
3. Opening mechanism, which allows you to take out conveniently the product from the (out of) package.

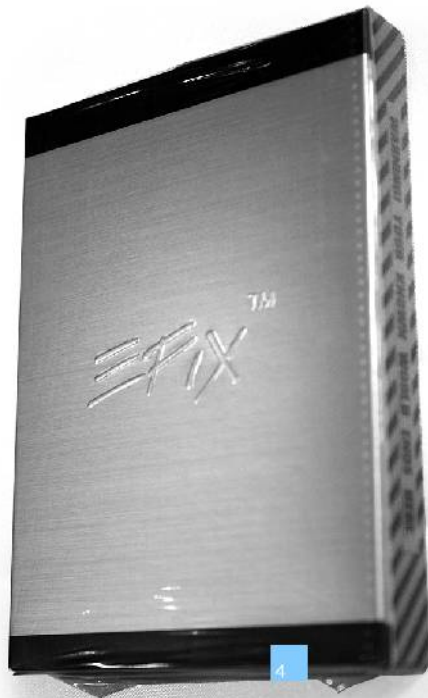
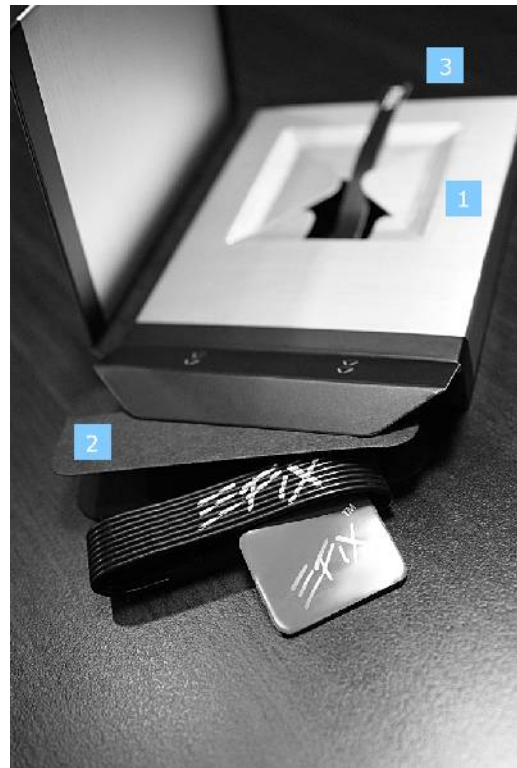

4. Plastic (single use) protective bag which does cover entire package and protects the Base Box against the dirt and mechanical damages or scratches.

This protective bag was applied at ASEM Factory and shows that the device is new and sealed.

3.1 Main Dimensions and Weights

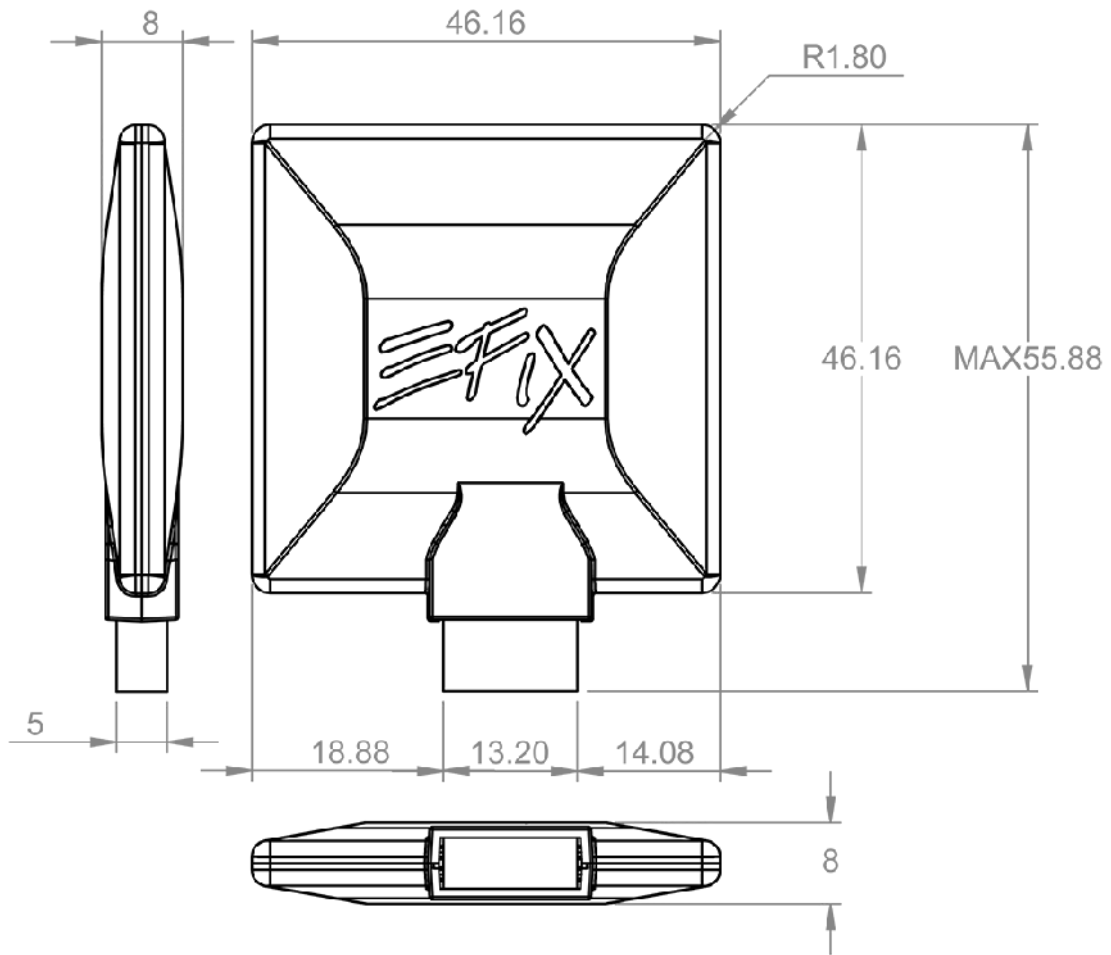

Weights:

- EFI-X BPU™ device: 21gr (+/- 2gr)

3.2 Technical Characteristics

USB Power

5 – 16 V

USB Data Line ESD Protection

IEC 61000-4-2 Level 4

- 15 kV (air discharge)

- 8 kV (contact discharge)

Peak pulse voltage

IEC 61000-4-2 air discharge 15 kV

IEC 61000-4-2 contact discharge 15 kV

MIL STD 883G-Method 3015-7: class 3B 25 kV

Materials

PCB: Gold Plated

PCB layer: each 2oz

Connectors

Internal 10-1 USB connector with protection “key”-pin.

USB revision

USB 2.0

3.2 Technical Characteristics

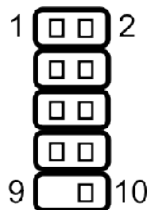

JUSB1
(USB v2.0 Intel spec)

PIN	SIGNAL	PIN	SIGNAL
1	VCC	2	VCC
3	USB0-	4	USB1-
5	USB0+	6	USB1+
7	GND	8	GND
9	Key	10	USBOK

3.3 Ambient Reference Conditions

 General approx. working parameters:

EFI-X BPU™

Approx. Operating Temperature Range: +10°C to +50°C

Environment

Maximum ambient temperature: +80 °C

Minimum ambient temperature: -10 °C

Relative humidity: 71%, no condensation allowed on non-isolated connectors

4. Connection with PC – Block Diagram

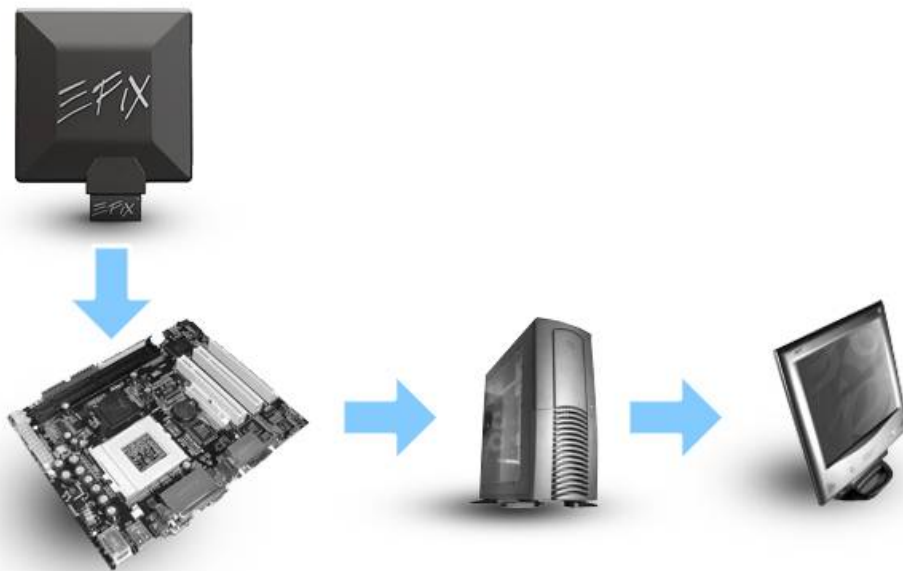

WARNING! Do NOT plug your EFI-X™ device into the FireWire header! This will cause your EFI-X™ device to fail and is NOT covered by warranty! Please refer to your motherboard's manual to identify the location of the internal USB headers!



5. General Installation Overview

 EFi-X BPU™ installation is very simple and requires just 3 easy steps.

1st Step

- Open your computer by unleashing screws

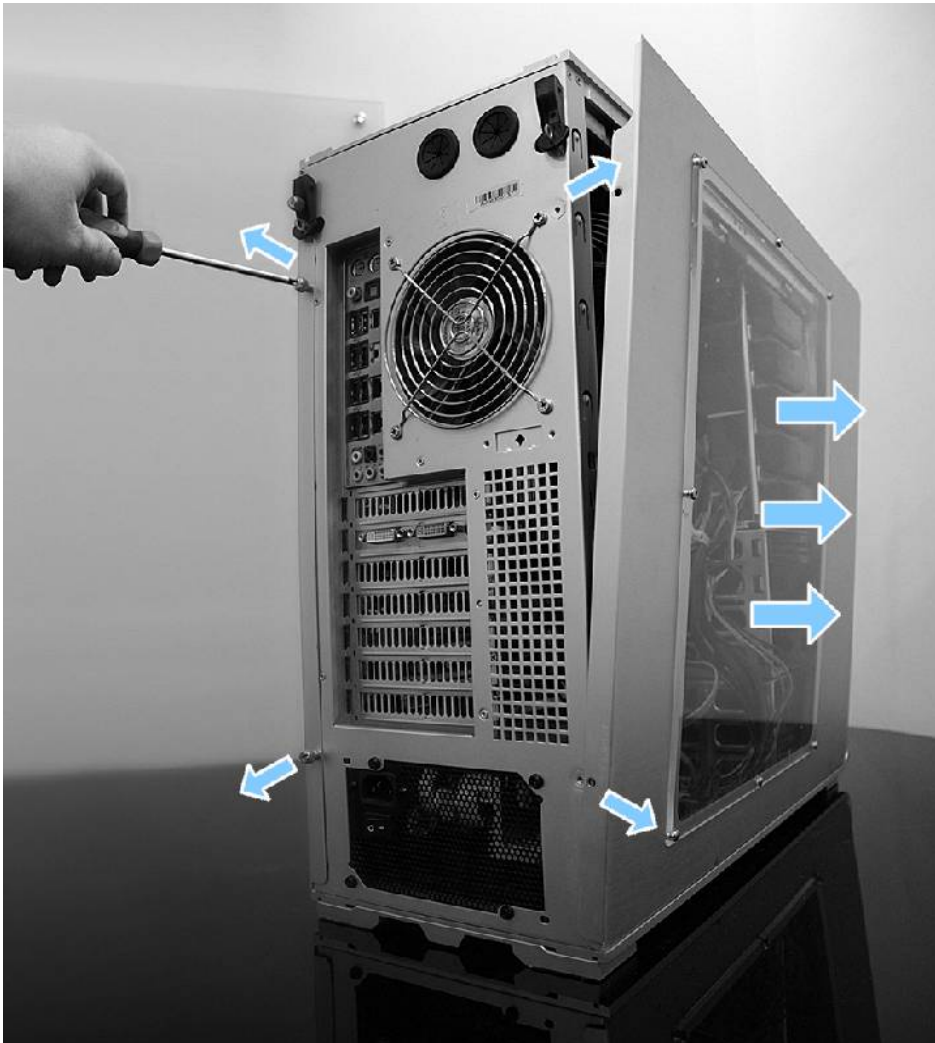

5. General Installation Overview

2nd Step

- Take off the cover of the computer

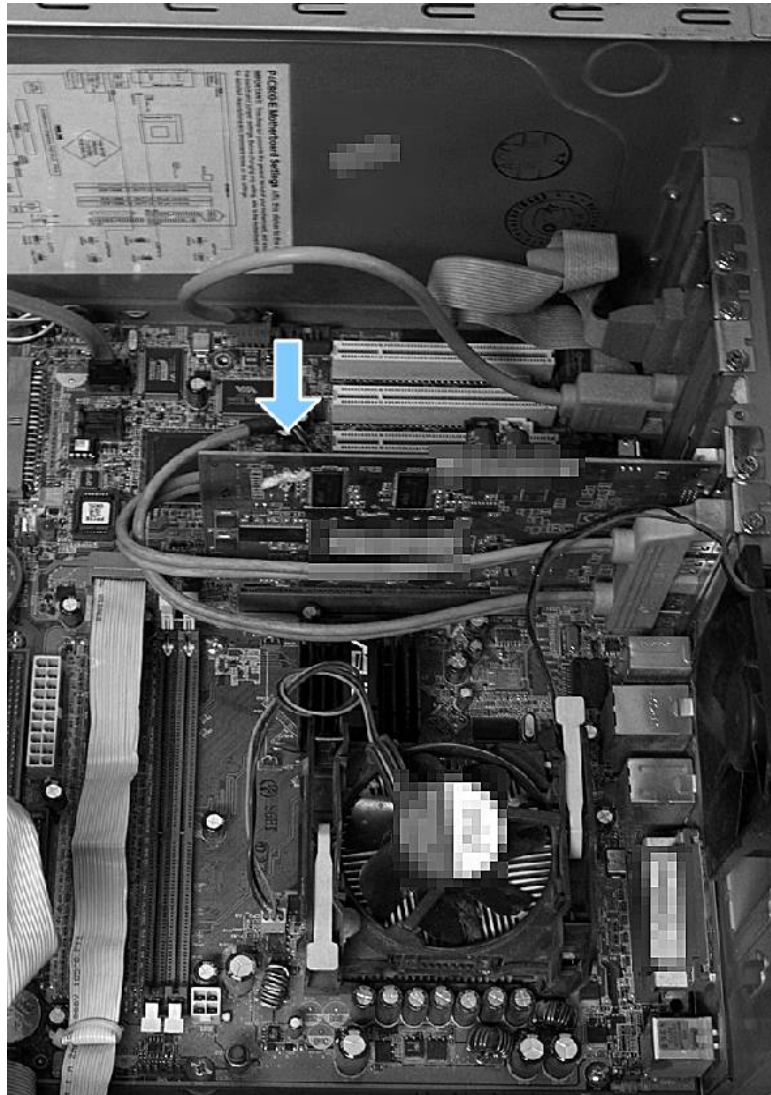

5. General Installation Overview

3rd Step

- Connect EFI-X™ device to a free 10-1 on-board USB connector on your motherboard and close your computer case.

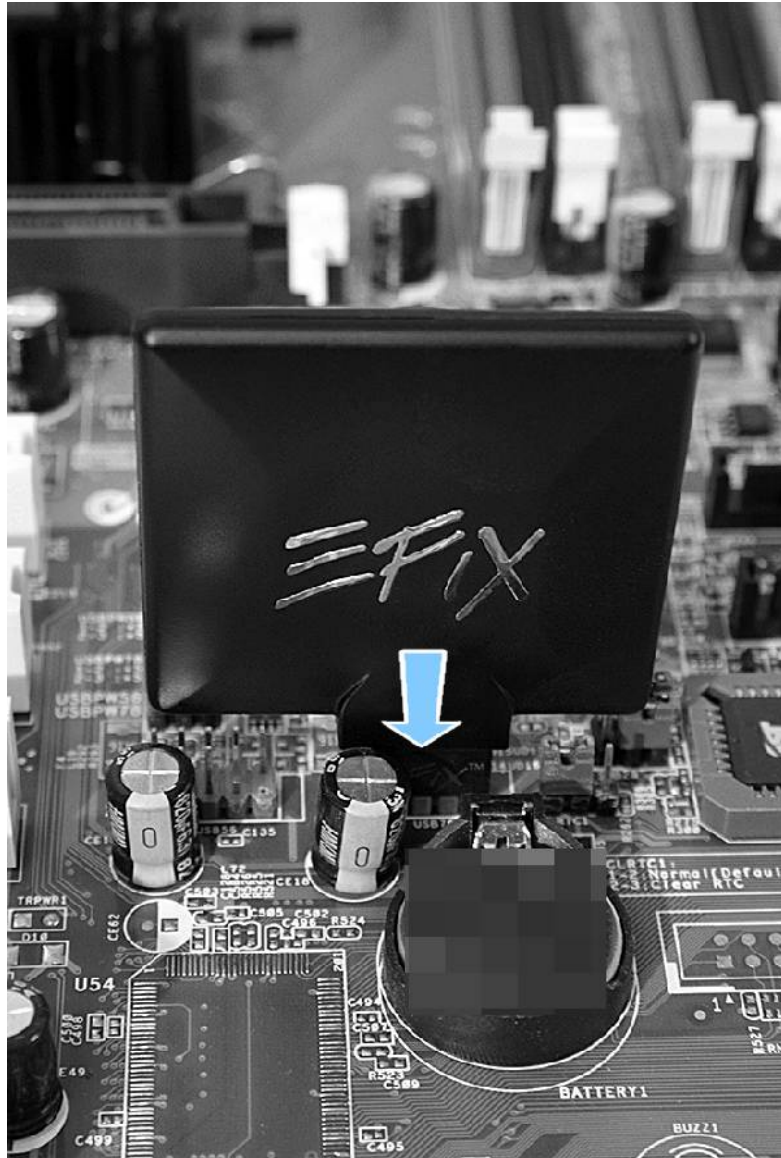

6. Certifications and Standards



Please Read Carefully:

Information in this document is provided solely in connection with Art Studios Entertainment Media Co., Ltd (ASEM) products. ASEM reserve the right to make changes, corrections, modifications or improvements, to this document, and the products and services described herein at any time, without notice. All ASEM products are sold pursuant to ASEM's terms and conditions of sale.

Purchasers are solely responsible for the choice, selection and use of the ASEM products and services described herein, and ASEM assumes no liability whatsoever relating to the choice, selection or use of the ASEM products and services described herein.

No license, express or implied, by estoppel or otherwise, to any intellectual property rights is granted under this document. If any part of this document refers to any third party products or services it shall not be deemed a license grant by ASEM for the use of such third party products or services, or any intellectual property contained therein or considered as a warranty covering the use in any manner whatsoever of such third party products or services or any intellectual property contained therein.

UNLESS OTHERWISE SET FORTH IN ASEM'S TERMS AND CONDITIONS OF SALE ASEM DISCLAIMS ANY EXPRESS OR IMPLIED WARRANTY WITH RESPECT TO THE USE AND/OR SALE OF ASEM PRODUCTS INCLUDING WITHOUT LIMITATION IMPLIED WARRANTIES OF MERCHANTABILITY, FITNESS FOR A PARTICULAR PURPOSE (AND THEIR EQUIVALENTS UNDER THE LAWS OF ANY JURISDICTION), OR INFRINGEMENT OF ANY PATENT, COPYRIGHT OR OTHER INTELLECTUAL PROPERTY RIGHT.

UNLESS EXPRESSLY APPROVED IN WRITING BY AN AUTHORIZED REPRESENTATIVE OF ASEM, ASEM PRODUCTS ARE NOT DESIGNED, AUTHORIZED OR WARRANTED FOR USE IN MILITARY, AIR CRAFT, SPACE, LIFE SAVING, OR LIFE SUSTAINING APPLICATIONS, NOR IN PRODUCTS OR SYSTEMS, WHERE FAILURE OR MALFUNCTION MAY RESULT IN PERSONAL INJURY, DEATH, OR SEVERE PROPERTY OR ENVIRONMENTAL DAMAGE.

Resale of ASEM products with provisions different from the statements and/or technical features set forth in this document shall immediately void any warranty granted by ASEM for the ASEM product or service described herein and shall not create or extend in any manner whatsoever, any liability of ASEM.

ASEM, ASEM logo, EFI-X, EFI-X logo, EFI-X logo and BPU are trademarks or registered trademarks of ASEM in various countries.

Information in this document supersedes and replaces all information previously supplied.

The ASEM logo is a registered trademark of Art Studios Entertainment Media Co., Ltd. All other names are the property of their respective owners.

© 1998 - 2010 Art Studios Entertainment Media Co., Ltd - All rights reserved

www.art-studios.net





ASEM

Art Studios Entertainment Media Co., Ltd

Art Studios Entertainment Media Co., Ltd.

www.art-studios.net

Address:

6F., No. 1-1, Nanjing W. Rd
Zhongshan District, Taipei City 104
Taiwan R.O.C.

Phone:

+886 (0) 2-8512-4946

Fax:

+886 (0) 2-8512-1790

Sales Dep.

sales@art-studios.net

ASEM Support Center

support@art-studios.net